



### AlphaESS Australia

**Hotline:** (02) 9000 7676 7:00 AM - 5:00 PM

**Email:** Sales Dept: [australia@alpha-ess.com](mailto:australia@alpha-ess.com) Tech Dept: [techsupport@alphaess.au](mailto:techsupport@alphaess.au)

**Website:** [www.alphaess.au](http://www.alphaess.au)

**Address:** 31 Richmond Rd, Homebush West, NSW 2140  
8 Walsh Ave, St Marys, SA 5042



# AlphaESS Australia

*Leading Brand in Energy Storage*

Operating in Australia for over **10** years.

Trusted by **100,000** Australian Families.

Your Partner in  
Every Endeavour

## **01 ABOUT ALPHAESS**

- Who We Are
- AlphaESS Australia

## **02 PRODUCTS & SOLUTIONS**

- Residential ESS
- Commercial & Industrial ESS

## **03 CASE STUDIES**

- Residential ESS
- Commercial & Industrial ESS

# 01

## ABOUT ALPHAESS

- Who We Are
- AlphaESS Australia



“  
Make clean energy  
accessible to everyone  
in the world.”

# WHO WE ARE

AlphaESS is a leading global green energy storage solution and service provider. With expertise in BMS, EMS, PCS, system integration, and cloud monitoring, we excel in providing tailored solutions for a wide range of applications, including residential, commercial & industrial, and utility-scale projects.

AlphaESS has 60+ subsidiaries and branches worldwide, including China, Germany, Australia, Italy, the United Kingdom, South Africa, Singapore, Malaysia, and more. With over 300,000 systems actively running across 130+ countries, we have built a comprehensive global supply chain and logistics network.

 **130 +**  
Countries & Regions

 **300,000 +**  
Systems Installed Globally

 **13 +**  
Years of Industry Experience

 **250 +**  
Patents in the ESS field

Discover more: [www.alphaess.com](http://www.alphaess.com)



**TOP 1**

Residential Energy Storage  
Provider in Australia



**TOP 1**

Residential Energy Storage  
Provider in the Netherlands



**TOP 5**

Residential Energy Storage  
Provider in Germany



**TOP 5**

Global Residential  
Storage Provider



Tier 1 Energy Storage  
Manufacturer  
by BloombergNEF 2025



The Most Recommended  
Brand in Germany



iF & Reddot & G-mark  
Design Award



TOP BRAND PV  
(STORAGE & INVERTERS)

# Global Service Network



400+

Global Service Network

## Key Networks

- Asia: China, Singapore, Malaysia, The Philippines, Myanmar, Indonesia, Uzbekistan, Japan, Thailand, Vietnam, Cambodia, Israel, Iraq
- Europe: Germany, United Kingdom, Italy, Benelux, France, Czech Republic, Spain, Estonia, Lithuania, Slovenia, Austria, Switzerland, Romania, Iberia
- Oceania: Australia, New Zealand, Fiji, New Caledonia, Tonga
- Americas: United States, Guam, Hawaii, Colombia, Peru, Chile, Brazil
- Africa: South Africa, Kenya, Nigeria, Ghana, Sierra Leone, Uganda, Mauritania

60+

Subsidiaries

5

Production Centers

China: Nantong (Tongzhou & Qidong), Ulanqab, Kunming  
Malaysia: Kulim



5

R&D Centers

Nantong, Suzhou, Nanjing, Tianjin, Xi'an



Headquarters



Subsidiary



Production Center

\*China: Nantong (Tongzhou & Qidong), Suzhou, Nanjing, Ulanqab, Beijing, Tianjin, Shenzhen, Guangzhou, Xi'an, Kunming, etc.

# ALPHAESS AUSTRALIA

2015

AlphaESS Australia was established

2017

One of only two manufacturers in South Australia listed as a Relevant Agent for the API control technology of Internet connected inverters

2021

Top Brand PV - Storage in Australia issued by EUPD Research



2026

Your Partner in Every Endeavour

2016

Launched "All-in-One" residential ESS in Australia



2019

- Launched the SMILE5 system
- Held the No.1 market share in Australia

2023

- Your Partner in VPP
- Top Brand PV - Storage in Australia issued by EUPD Research



2025

- Tier 1 Energy Storage Manufacturer by BloombergNEF 2025



# Local Service



50+

Local Service Personnel



5

Service Points Across Five States



## How to find us?



Hotline

(02) 9000 7676  
7:00 AM - 5:00 PM



Email

Sales Dept: [australia@alpha-ess.com](mailto:australia@alpha-ess.com)  
Tech Dept: [techsupport@alphaess.au](mailto:techsupport@alphaess.au)



Monitoring Platform

AlphaCloud / AlphaPartner



Website

[www.alphaess.au](http://www.alphaess.au)

# Customer Service

AlphaESS provides timely and efficient after-sales support to our installers, end users and other partners in a variety of ways.

- **Technical Support:**

Dedicated customer service from start to finish with our service staff.

- **AlphaCloud:**

A lifetime-free energy management and monitoring platform for All AlphaESS systems.

- **AlphaPartner:**

Exclusive service platform for AlphaESS' partners including distributors and installers.



Individual Account



Instant Messaging



Work Order Management



\*Service items may vary by country/region, please contact your local AlphaESS business manager for further details.

AlphaPartner  
(Web + App)

AlphaCloud  
(Web + App)

# 02

## PRODUCTS & SOLUTIONS

- Residential ESS
- Commercial & Industrial ESS

## ***Residential ESS***

AlphaESS provides energy storage solutions for households.

With the AlphaCloud monitoring platform, users can fully enjoy the economic benefits and convenience of smart energy management.



# SMILE-G3 Series

YOUR ALMIGHTY KNIGHT

SMILE-G3-T5~20

SMILE-G3-S5

SMILE-G3-B5



GOOD DESIGN AWARD



red dot design award

# SMILE-G3



# 01

## New Product

The AlphaESS SMILE-G3-T series is the next generation of three-phase hybrid energy storage, specifically engineered to power the modern, all-electric Australian home. Coming soon to the Australian market in 5kW, 10kW, 15kW, and 20kW power ratings, this "all-in-one" solution integrates a high-performance inverter with the latest AlphaLinX battery technology, offering a massive 200% PV oversizing capability and a seamless <10ms blackout protection that ensures your entire household remains powered during grid outages. Whether you are balancing heavy appliance loads or participating in a Virtual Power Plant (VPP) to maximise your ROI, the SMILE-G3-T series offers a future-proof, scalable energy hub backed by AlphaESS Australia's local support team.



### SMILE-G3-T5~20

Nominal Output Power: 5 - 20 kW

Capacity: 9.3 - 55.8 kWh

Phase: Three Phase



3 MPPT Design  
Higher-PV Output



Redundant Design  
No HV Box



Intelligent Bypass  
Technology



T5 - T10  
Datasheet



T15 - T20  
Datasheet

# 02

## New Installation

DC-Coupled

### SMILE-G3-S5

<b>Model</b>	SMILE-G3-S5
<b>Nominal Output Power</b>	5 kW
<b>Phase</b>	Single Phase
<b>Capacity</b>	10.1 - 60.6 kWh (for BAT - 10.1P) 9.3 - 55.8 kWh (for BAT - 9.3S)



Datasheet



Faster Response for VPP Control



Built-in Changeover Switch Functionality



24/7 Online Monitoring



All-in-One



UPS Ability

# 03

## Added-On Installation

AC-Coupled

### SMILE-G3-B5

<b>Model</b>	SMILE-G3-B5
<b>Nominal Output Power</b>	5 kW
<b>Phase</b>	Single Phase
<b>Capacity</b>	10.1 - 60.6 kWh (for BAT - 10.1P) 9.3 - 55.8 kWh (for BAT - 9.3S)



Datasheet



Switch Built-in Installation-free



All-in-One



Products for Added-On Energy Storage System

# SMILE-M series

STACKABLE DESIGN, NEW EXPERIENCE



TAILORED FOR AUSSIE SUBSIDIES

COMING SOON

Q3



## SMILE-M10-S

Nominal Output Power: 10 kW  
Capacity: 13.99 kWh - 27.98 kWh  
Phase: Single Phase

Datasheet



### Perfect Fit for Subsidy

Engineered to capture the maximum **14 and 28 kWh rebate** thresholds



### All-in-One Design

Design compact neat, and easy to deploy



### Maximize Your Revenue

Integrate 30+ mainstream VPP aggregators



### 5 Minute Commissioning, Quick Setup

Rapid App commissioning with built-in CT & meter self-check



### Multiple safety protections

Full protection from cells to system



### 200% PV oversizing

4 MPPTs Maximize your solar utilization

# New Product

AlphaESS Australia is excited to announce the upcoming launch of the SMILE-M5, designed to deliver an unparalleled installation experience. This innovative product simplifies system configuration steps and eliminates the need for manual cable connections between stacked batteries. Additionally, the introduction of battery content aerosols significantly reduces the potential risk of fire, ensuring the safety of homeowner's property. With a large allowable PV installed capacity, the SMILE-M5 maximises homeowner's investment and empowers them to embrace a sustainable energy future with confidence.



## Exclusive Partner Service — AlphaPartner (Preview Version)



### Quick Self-Check and Accurate Diagnosis

Automatic fault point identification and repair guidance



### Work Order Tracking and Service Guidance

Real-time logistics status updates and step-by-step service instructions

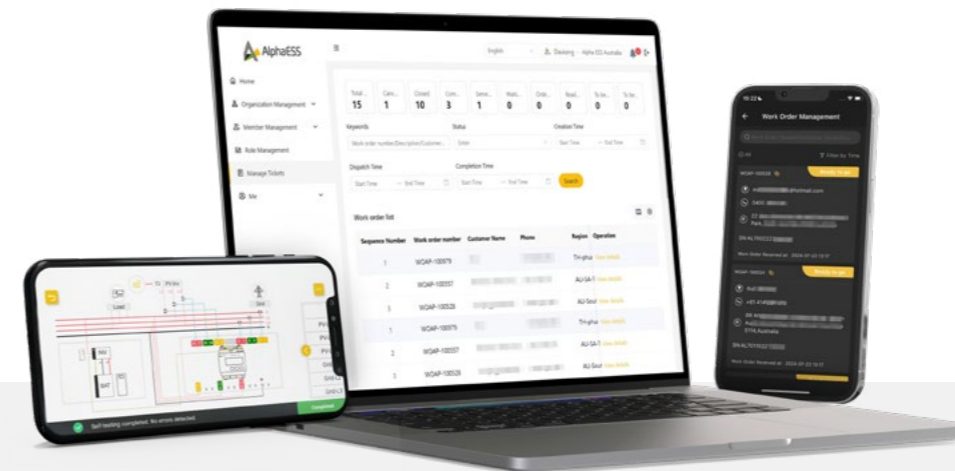

Scan the QR code to download AlphaPartner App.



### SMILE-M5-S

Nominal Output Power: 5 kW

Capacity: 5 - 30 kWh with BAT-5P

13.99 - 27.98 kWh with BAT-13.9P

Phase: Single Phase

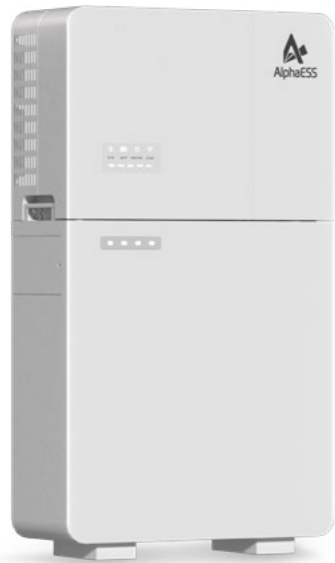

Plug In & Power Up with Ease



Efficiently Reduce Fire Hazards



Expert in All-in-One System



Get More Out of Every kWh Installed

Datasheet



# Commercial & Industrial ESS



High Energy Density

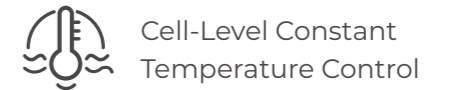

Cell-Level Constant Temperature Control

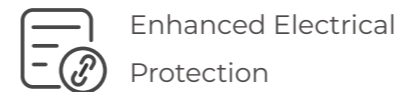

Enhanced Electrical Protection



Intelligent Fire Protection

# 01

## Applications



### Schools, Hospitals and Banks

Energy Efficiency for Vital Spaces  
Where Every Watt Matters



### Commercial Office Buildings

Energy Resilience for  
Business Excellence



### Small Factories

Fueling  
Industry,  
Energising  
Growth

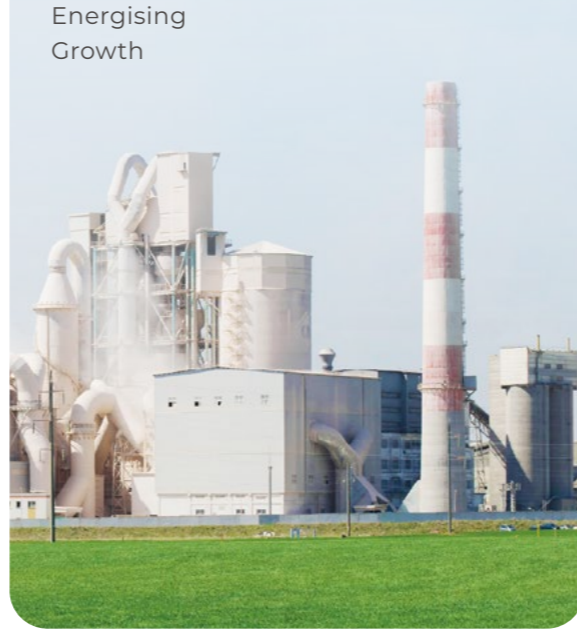

### Islands

Island Energy Independence,  
Harnessing Power from Nature

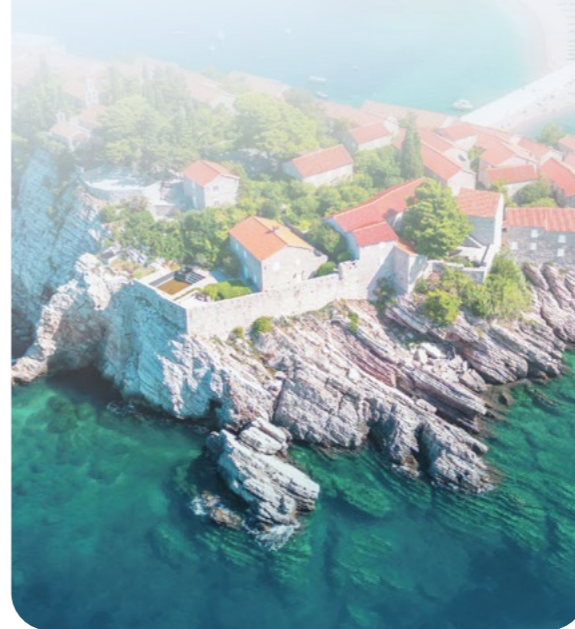

### Mining Sites

Unearth the Power, Illuminate  
the Depths



# 02

## Solutions

### ► DC-Coupled System

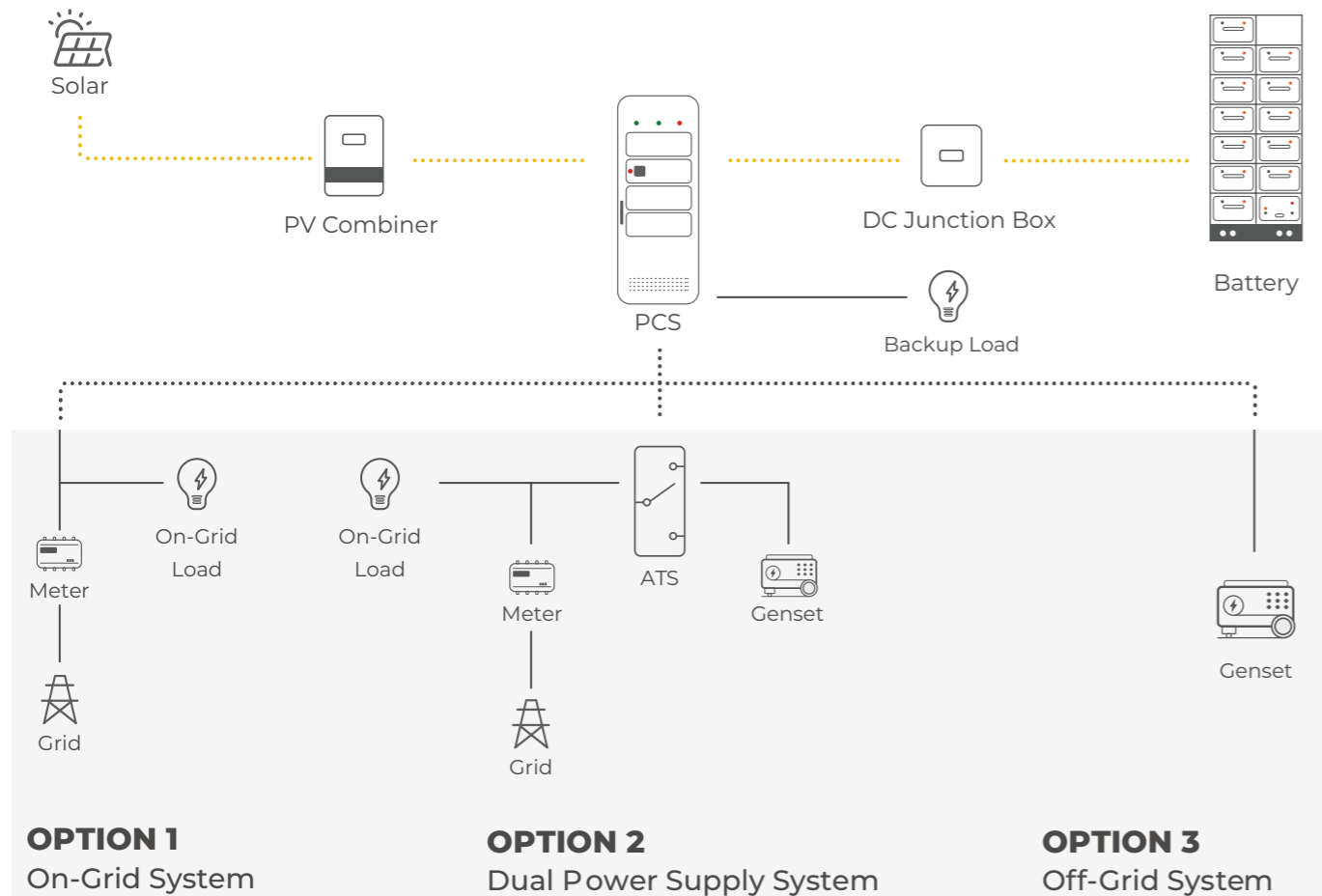

### ► AC-Coupled System

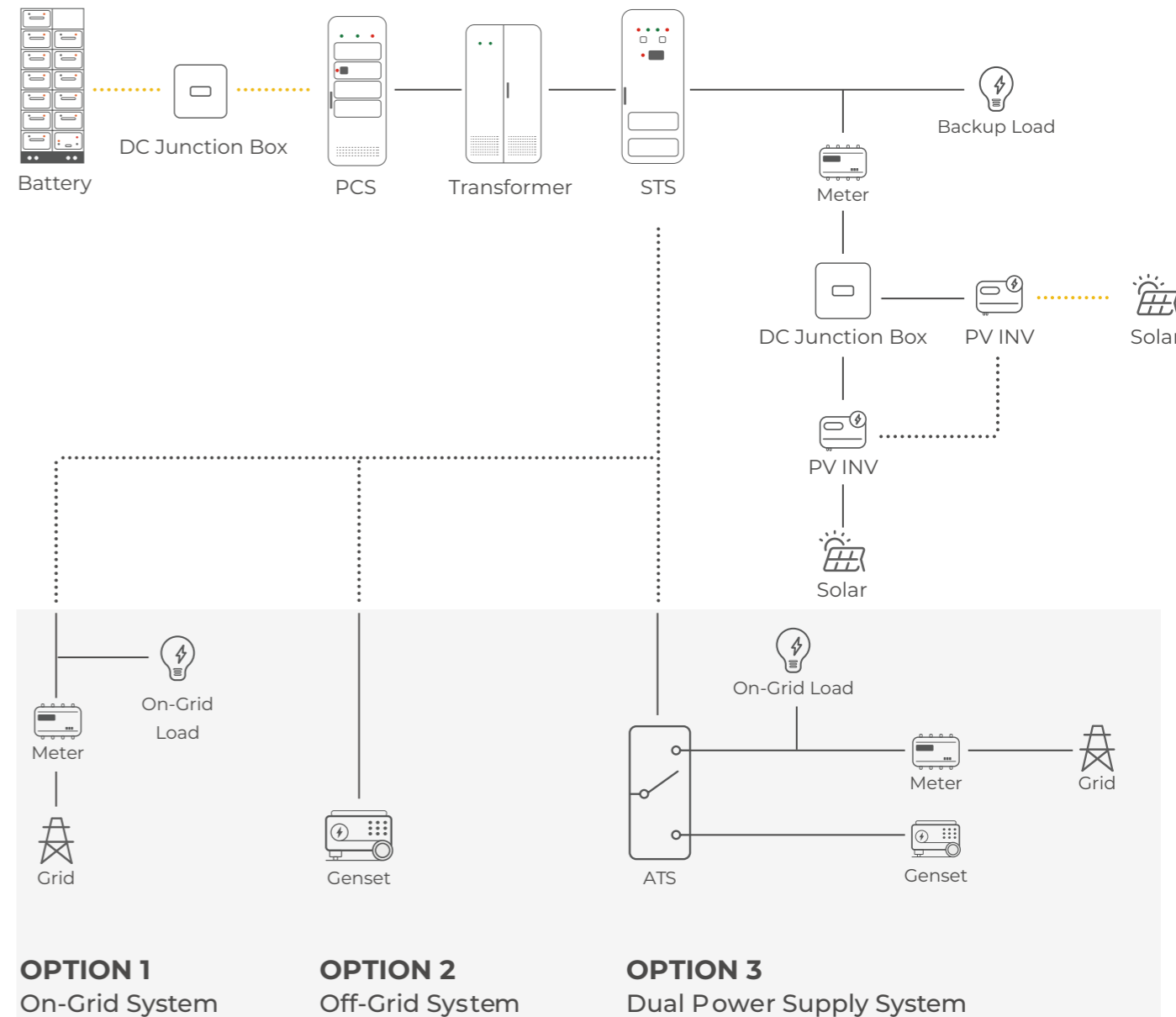

# 03

## New Product

### StaX-M30/50

#### Commercial Power Residential Ease

StaX is a compact, modular commercial energy storage system designed for easy installation and flexible expansion. With silent, wiring-free operation and a stackable design, it delivers reliable power for small businesses—anytime, anywhere.

**• Designed to Save, From Time to Cost**

- No Heavy Truck Needed, Skip the Crane, Easy Handling
- Easy Access in Tight Spaces, Stack and Go

**• Flexible Storage, Optimised for Every Project**

- 10.75 kWh Modular Design for Precise Scaling -Expand with Ease
- IP66 & Battery Heating (-20°C to 50°C)

**• Maximise Your Solar Energy, Reduce Energy Costs**

- AC / DC Coupled
- 200% PV oversizing for maximising Self-Consumption
- Actively balances each module to maximise capacity and extend lifespan
- Automatically isolates faulty modules without system shutdown
- Should be Supports dynamic tariffs and electricity trading



Model	StaX-M30/50
Rated Power	30 kW / 50 kW
Rated Energy	53.76 - 193.536 kWh for M30 (100% DoD)   96.768 - 193.536 kWh for M50(100% DoD)
Ingress Protection	IP66
Battery Type	LiFePO <sub>4</sub>
Fire Protection	Aerosol, Explosion Relief
System Power	160%, 10s overload capacity, 100% unbalanced output
Warranty	10 years system and battery warranty
PV	3 MPPT, 6 Strings / 4 MPPT, 8 strings 40A input current 200% PV oversizing
Battery Module	M38280-S



- Save 30% Installation Time: No battery rack or wiring needed — just stack and start
- Self-optimizing Batteries: Hassle-free Maintenance
- Easy Expansion: Free you from time-consuming capacity balancing
- Boost Lifetime Output: Automated diagnostics & calibration for SOC consistency
- 200% PV input to boost profits

Datasheet



# 03

## CASE STUDIES

- Residential ESS
- Commercial & Industrial ESS

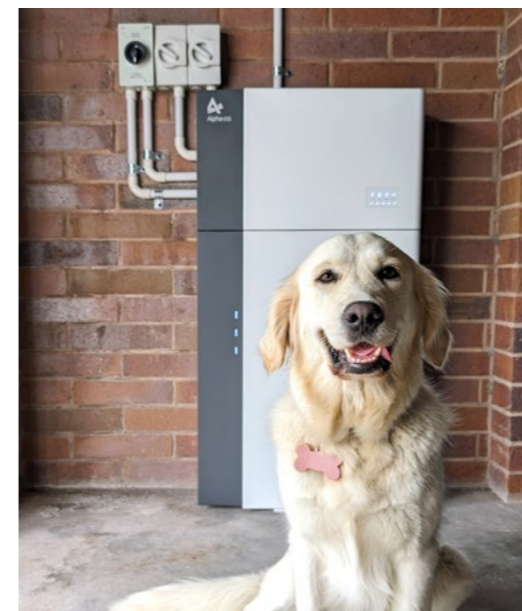

## 100kW / 250kWh

PV + Storage + Off-Grid  
Moomba, South Australia

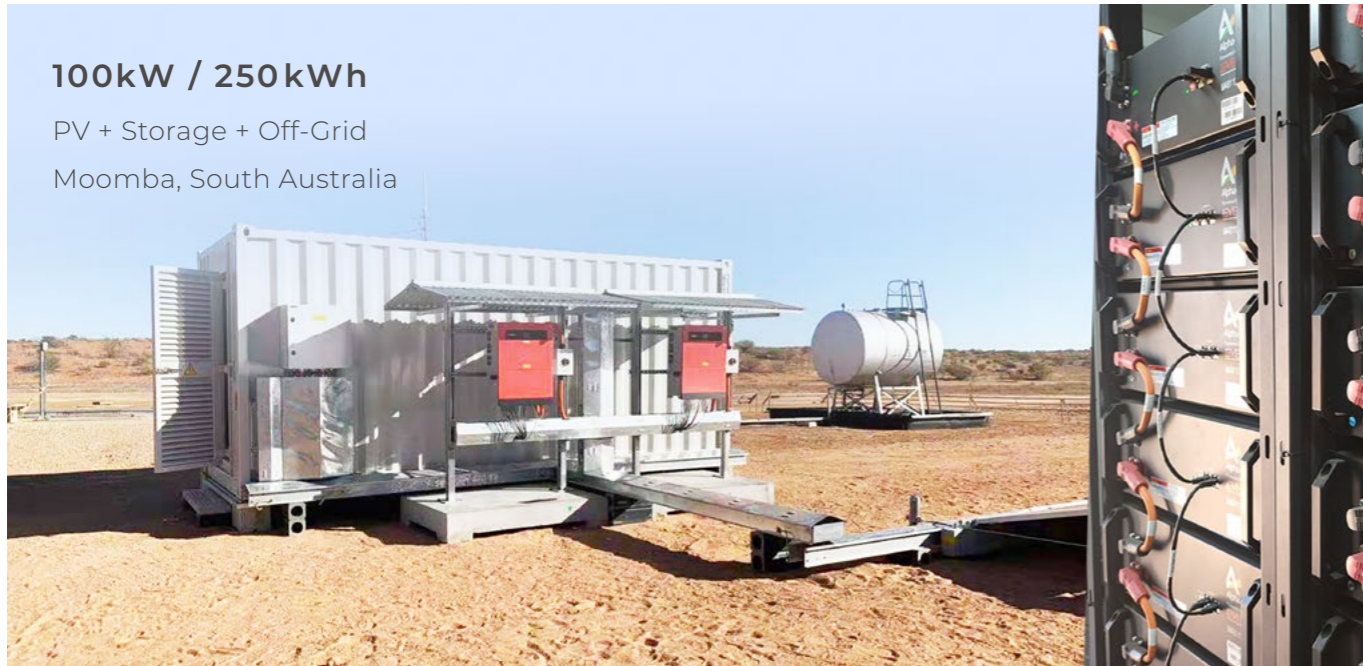

## 100kW / 670kWh

PV + Storage + Microgrid  
Fremantle, Western Australia



1

2

3

4

**1** 50kW / 200kWh  
PV + Storage  
Perth, Western Australia

**2** 50kW - 100kW /  
100kWh - 300kWh  
Solar-Battery-Diesel  
Microgrid System  
Myanmar, Southeast Asia

**3** 100kW / 206kWh  
PV + Storage + Genset  
Abu Dhabi, UAE

**4** 500kW / 1MWh  
PV + Storage + Genset  
Zimbabwe, Africa